



M0103



M0600

# Totes & Boxes

litho-mounted corrugated, paperboard, turned edge



CUSTOM

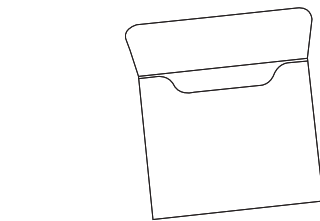

7200 12" W x 10" H  
No Capacity  
Fold Down Flap

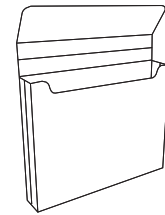

4108 11-3/4" W x 9-1/4" H  
2" Expandable Capacity  
Fold Down Flap  
Side Gussets Ship In, Bottom Out  
\*Various Capacities Available

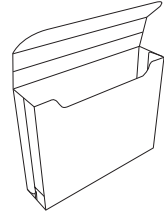

4101 11-3/4" W x 9-1/4" H  
2-3/4" Expandable Capacity  
Fold Down Flap  
Side Gussets Ship In, Bottom Out  
\*Various Capacities Available

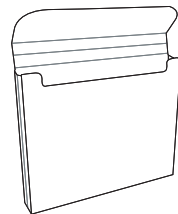

4406 11-3/4" W x 9-5/8" H  
1-1/2" Expandable Capacity  
Fold Down Flap  
Side Gussets Ship In, Bottom Out  
\*Various Capacities Available

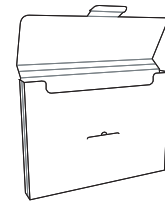

7713 11-3/4" W x 8-5/8" H  
1-1/4" Expandable Capacity  
Fold Down Flap w. Tuck Tab Closure  
Side Gussets Ship In, Bottom Out  
\*Various Capacities Available

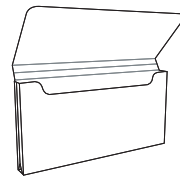

7148 10" W x 5" H  
3/4" Capacity  
4" Fold Over Flap  
Gussets Ship Out

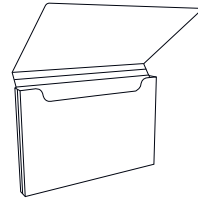

7374 9" W x 6" H  
3/4" Capacity  
Full Fold Over Flap

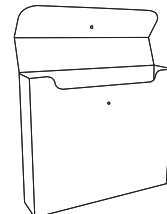

7581 11-3/4" W x 10" H  
2-1/2" Fixed Capacity  
Fold Over Flap  
Auto Lock Bottom  
\*Various Capacities Available

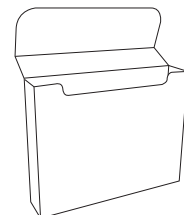

7370 12-3/4" W x 10" H  
2-1/2" Fixed Capacity  
Fold Over Flap, 1-2-3 Bottom  
\*Various Capacities Available

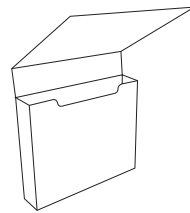

7002 11-1/2" W x 9-1/2" H  
2-1/4" Fixed Capacity  
Full Fold Over Flap  
Tuck-End Bottom

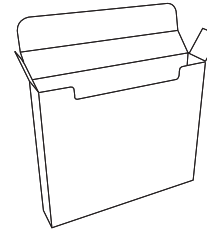

4308 11-3/4" W x 10" H  
2" Fixed Capacity  
Side 'Wings' & Fold Over Tuck Flap  
1-2-3 Bottom

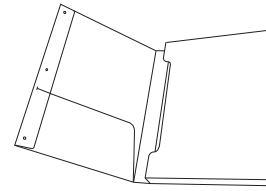

7628 9-1/4" W x 12-1/4" H  
1-1/4" Capacity  
4-1/2" H Pocket  
Side Reinforcement w. T-Slit

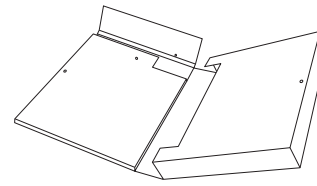

7518 9-3/16" W x 11-7/8" H  
1-31/32" Capacity  
3/8" Capacity Box Pocket w. Flap  
Optional Corrugated Insert

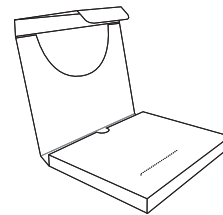

7554 7-5/16" W x 9-5/16" H  
13/16" Capacity  
Full Pocket with 'Dip Cut'  
Wrap Around Flap w. Tuck Tab

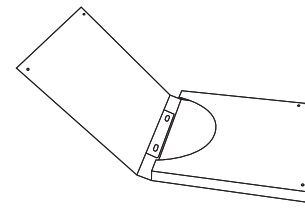

7578 11-1/2" W x 11-9/16" H, 1" Capacity  
Full Super Constructed Flap  
Tuck End w. Lock Tabs  
Designed w. Plastic Handle [Optional]

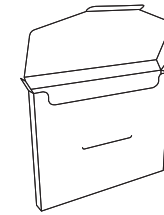

7615 11-1/4" W x 3-3/4" H  
15/16" Fixed Capacity  
Side 'Wings' & Fold Down Flap w. Tuck Tab

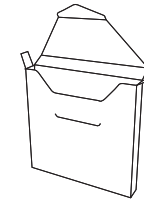

7648 5" W x 5-1/8" H  
5/8" Capacity, Tuck End Bottom  
Side 'Wings' & Fold Down Flap w. Tuck Tab

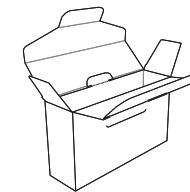

7624 4-3/16" W x 7-3/8" H  
2-1/6" Capacity  
[1] Fold Over Flap w. Tuck Tab [Side 'Wings']  
[1] Wrap Around Flap w. Tuck Tab

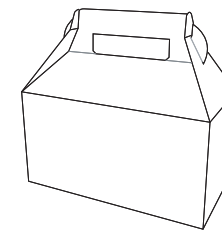

7271 11-1/2" W x 6" H  
6" Capacity, Auto-Bottom  
Built in Handle & Lock Tabs

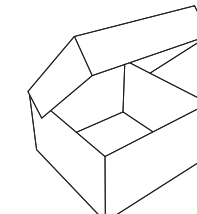

7253 7-3/4" W x 7-3/4" H  
4-9/16" Capacity  
Simplex Lid, 1-2-3 Bottom  
Ideal To Hold Baseball Cap

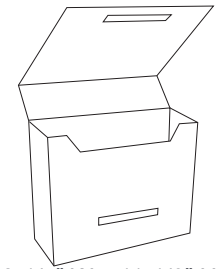

0700 12-1/4" W x 11-1/8" H  
3-3/4" Capacity  
8" Fold Down Flap  
Turned Edge Construction  
\*Available in Various Sizes

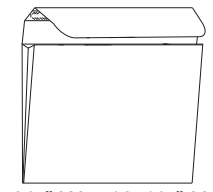

7330 10-3/4" W x 13-1/4" H  
2" Capacity at Top - 0" at Bottom  
Zip Strip w. Double Sided Tape  
Fold Over Flap

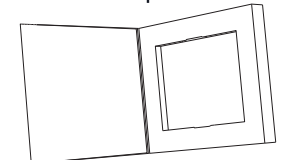

8496 7" W x 6" H, 3/4" Capacity  
5" W x 4" H Insert Cut Out  
Super Constructed Fifth Panel  
\*Option to Use as Custom Mailer

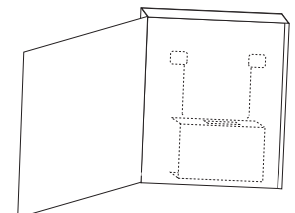

7237 8-1/2" W x 10" H, 1-5/8" Capacity  
Super Constructed Cover Panel  
Built in Platform to Hold Manuals  
1-2-3 Bottom, Tuck End Top

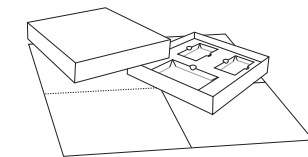

GAME Outer Box: 12-1/4" W x 12-1/4" H x 2" D  
Insert to Hold Game Cards  
Game Board: 23-1/2" W x 23-1/2" H  
Die Cut in Board for Easy Folding  
\*Various Sizes Available



Elastic Loop



Leather Strap w. Metal Snap



Metal Handle



Soft Plastic Handle



Hard Plastic Handle



Metal & Plastic Clips

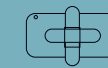

Latches



Metal or Plastic Snap

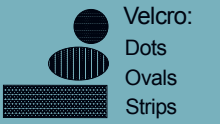

Velcro:  
Dots  
Ovals  
Strips

# Totes & Boxes [Continued]

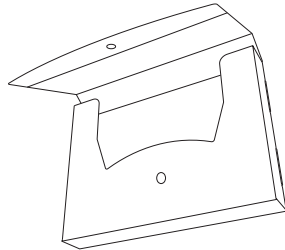

M0250 12" x 9" H x 1-5/8" Capacity  
Front Flap with Magnet Closure

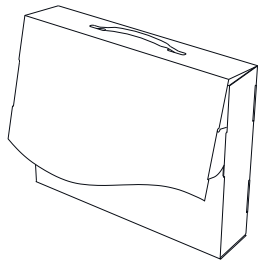

M0423 12" W x 10" H  
2-1/2" Capacity  
12" W x 7-1/5" H Flap with  
Double Magnet Closure  
Tuck Tabs & Plastic Handle

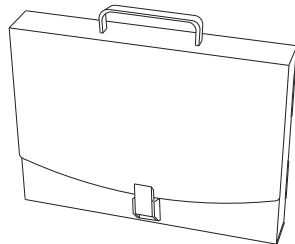

M0395 12" W x 9" H, 1-3/4" Capacity  
12" W x 8-1/5" H Flap with  
Plastic Clip Closure  
Plastic Handle

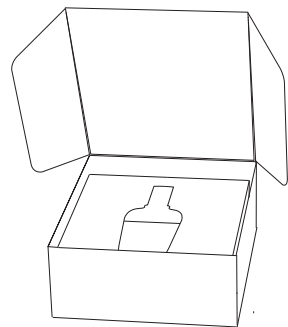

7982 7" W x 8-1/4" H x 3" D  
Super Constructed Lid  
Foam Insert with Custom Die Cut  
to Display Perfume Bottle

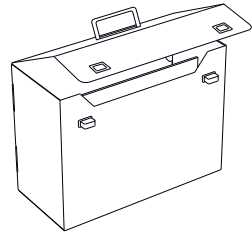

M0365 13-1/4" W x 10" H x 6" Capacity  
6" Capacity Tote Box  
Twist Locks and Plastic Handle

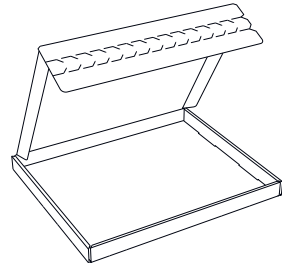

9316 11-1/4" W x 9-1/2" H x 7/8" Capacity  
Corrugated Box with Zip Strip Closure  
Designed as Custom Mailer  
Various Sizes/Style Available

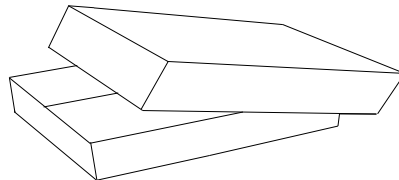

M0462 10-1/4" x 8-1/4" x 1-1/2" deep  
[2] Piece Turned Edge Telescoping Box  
[Reference #SL2302-I&II]

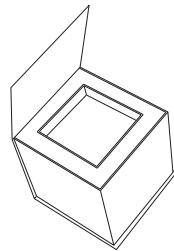

M0058 6" W x 6" H x 3-3/4" D  
Turned Edge Lid with Concealed  
Magnet Closure  
4" x 4" Well to House Foam Insert

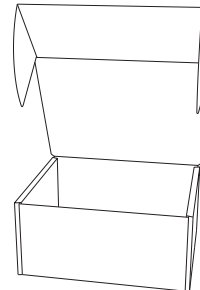

M00336D 4-3/4" W x 4" H x 2-3/8" D  
Econo Style, 2 Side Rollover  
with Cover Flaps

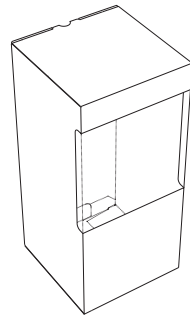

M0405 6" W x 13" H x 6" D  
w. 6" x 6" Clear Plastic Window

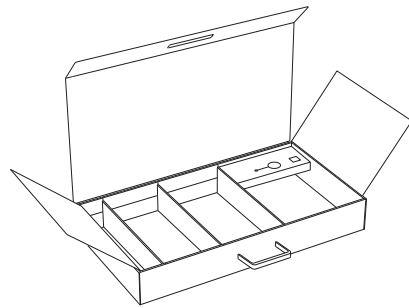

M0114 25-1/2" W x 14" H x 3-3/4" D  
Custom Insert and Compartments  
Constructed from Dies #M0014-I, II, III  
Plastic Handle

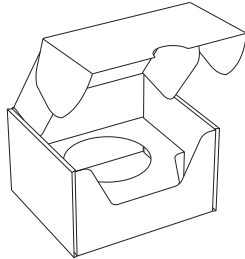

M0472 5-1/2" W x 4-3/4" x 3" D  
Custom Insert Designed to Hold Baseball  
Rollover Sides with Tuck Tab Closure

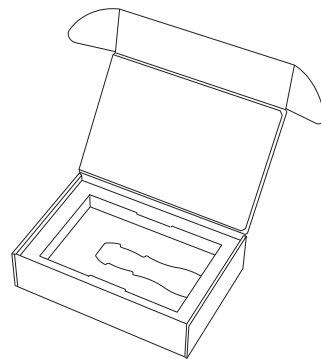

M0526 9-1/2" x 6-1/2" x 2-1/2"  
7-1/2" x 5" x 1" Well  
Custom Die Cut to Hold Tool



9105CTN



7982



M0423

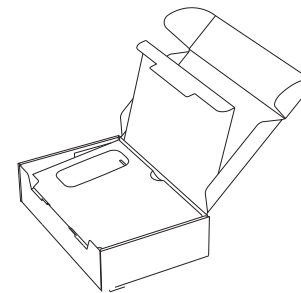

M0404 10" W x 6-1/2" H x 2-1/2" D  
Display Box with Custom Platform

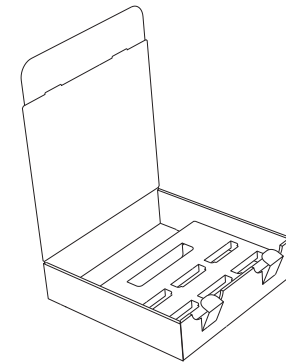

M0508 10" W x 10" H x 2-1/2" D  
Front Tuck & [2] Locking Tabs  
Optional Custom Insert

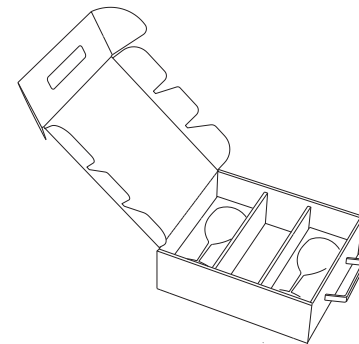

M0565 9-3/4" W x 11-3/4" H  
3-3/4" Capacity  
Litho Mounted Corrugated Display  
Box with Custom Wine Glass  
Insert

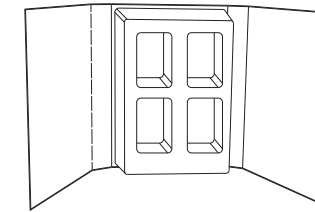

1048 9" W x 12" H, 2" Capacity  
Custom Adhered Plastic Tray

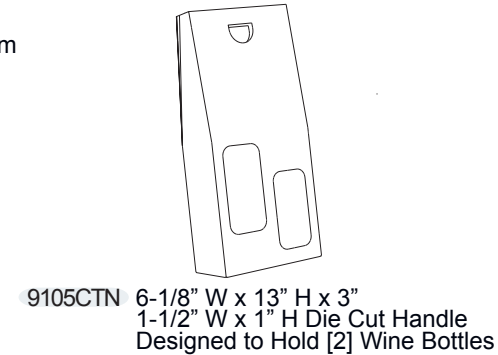

9105CTN 6-1/8" W x 13" H x 3"  
1-1/2" W x 1" H Die Cut Handle  
Designed to Hold [2] Wine Bottles

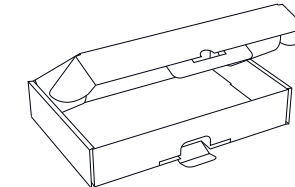

9273 7-3/4" W x 5-1/4" H x 1-1/2" D  
Box with Mailer Lock

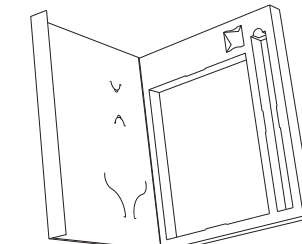

8823CTN 11-3/4" W x 14-1/2" H, 1-1/4" Capacity  
14-1/2 x 1/2" Flap w. Concealed Magnet  
Built in Platforms to Hold Rolled Poster,  
Brochure Counter top Display  
Foam Insert to Hold Label Pin  
Super Constructed Left Panel w. Die Cut  
Slits to Hold CD and Window Decal

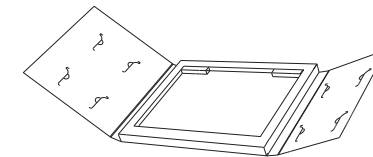

8879 11-1/16" W x 8-3/4" H x 13/16" D  
Paperboard 6 Panel Display Box

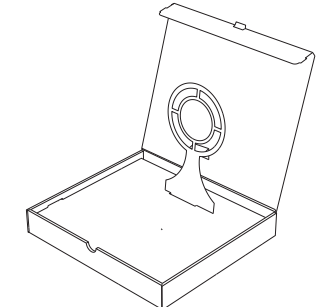

M0537 10-1/2" W x 9-1/2" H x 1-1/2" D  
Die Cut Corrugated 'Target' Pop-Up  
Tuck Tab Close with Thumb Notch

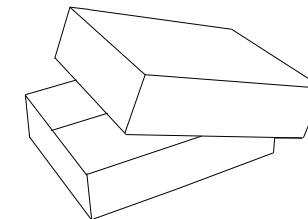

M0463 12-2/3" x 10-1/2" x 2-1/4" deep  
[2] Piece Turned Edge Telescoping Box  
[Lid Reference #SL2307-I&II]

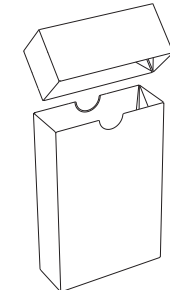

7672 6" W x 8-3/4" W, 2" Capacity  
6-1/8" x 2-1/4" x 2-1/8" Lid  
[2] Piece Paperboard Box